

# grandgousier

gauthier auclerc

02/2008

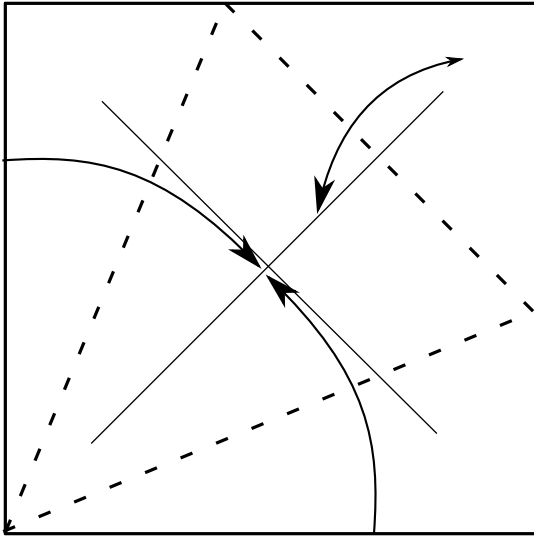

1 commencer couleur dessous

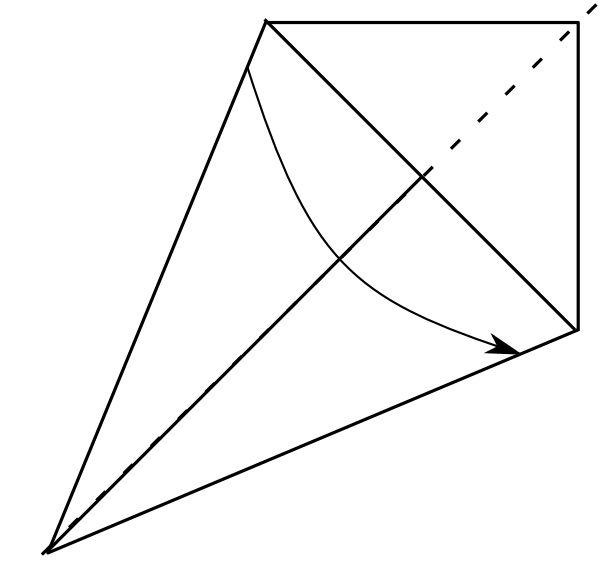

2 plier en deux

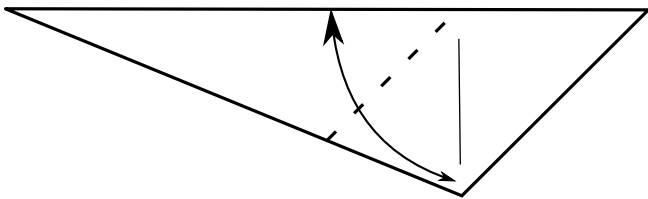

3 marquer le pli

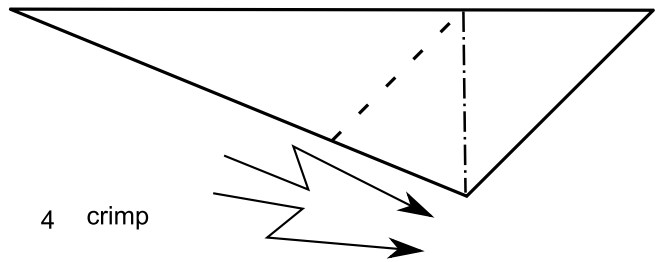

4 crimp

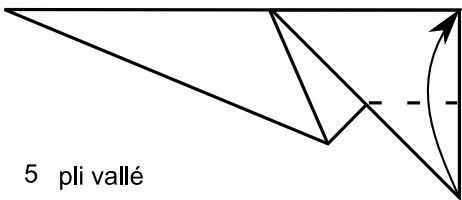

5 pli vallé

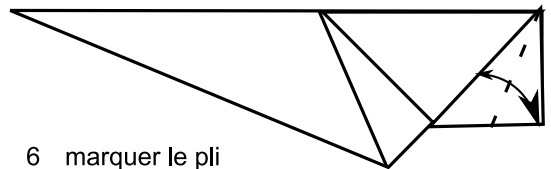

6 marquer le pli

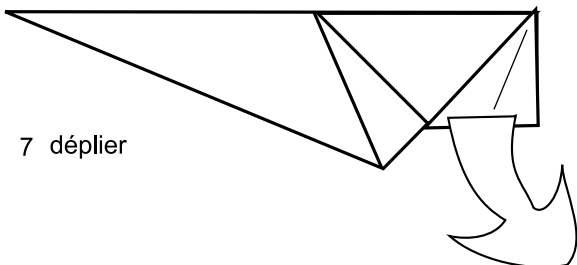

7 déplier

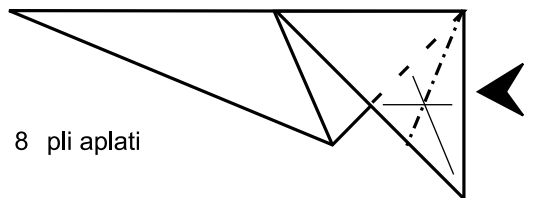

8 pli aplati

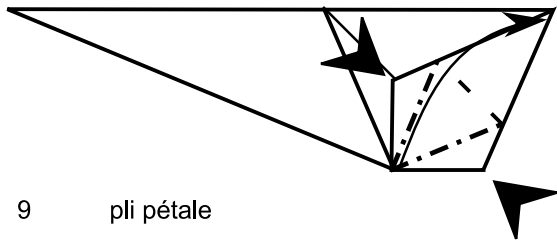

9 pli pétale

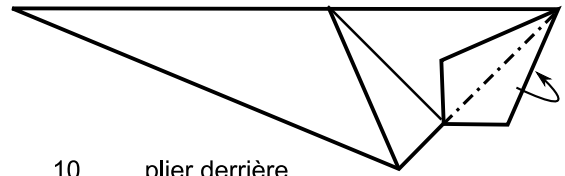

10 plier derrière

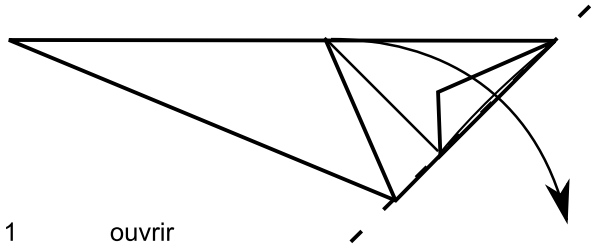

11 ouvrir

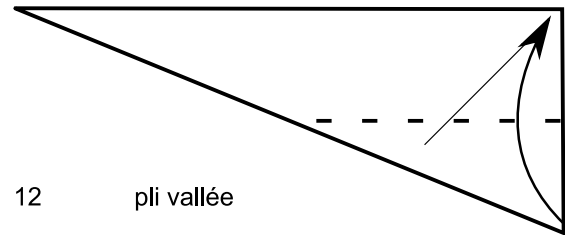

12 pli vallée

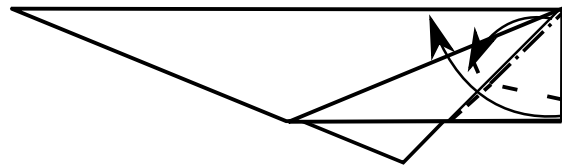

13 replier en inversant la pointe

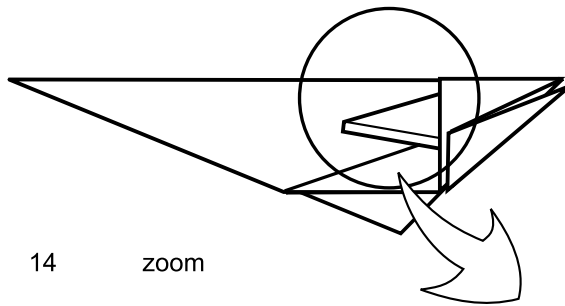

14 zoom

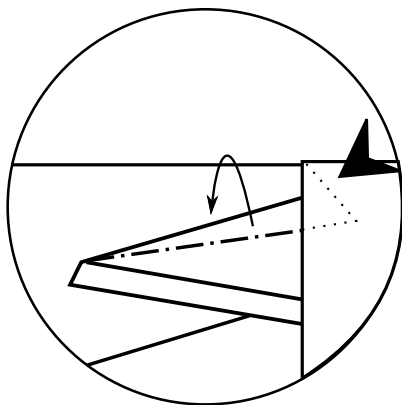

15 pli pivot

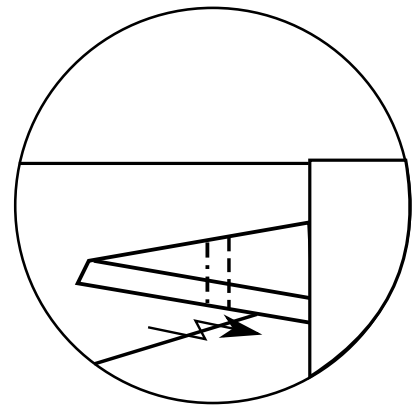

16 repli

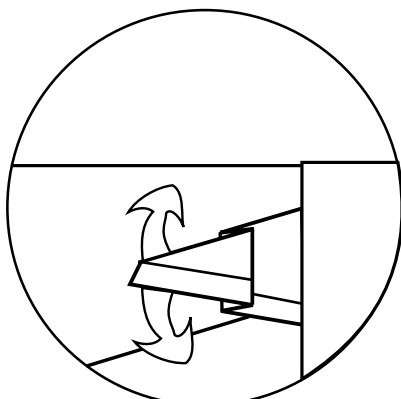

17 sortir des épaisseurs

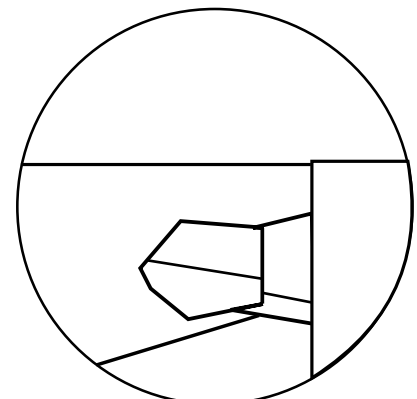

18 nageoire terminée

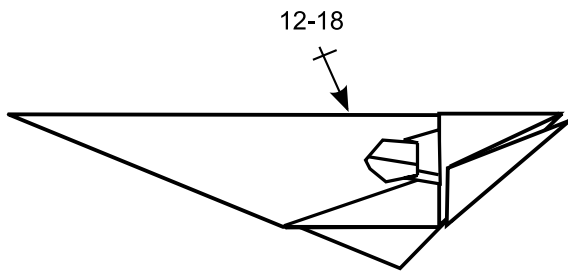

19 repeter les étapes 12 à 18  
de l'autre coté

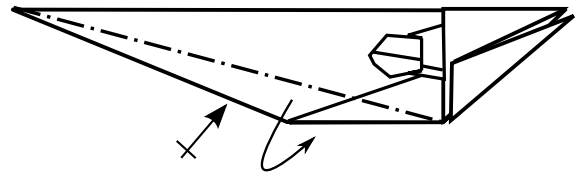

20 pli montagne  
repeter derriere

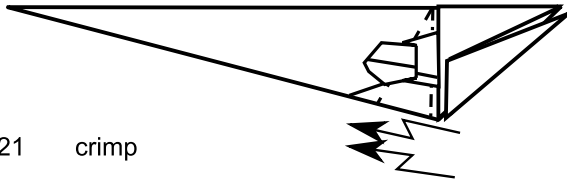

21 crimp

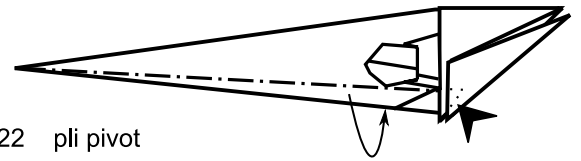

22 pli pivot

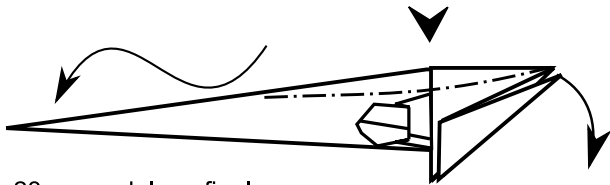

23 modelage final