

Anatida

Juan Pedro Rubio Peña

Madrid, February 2003

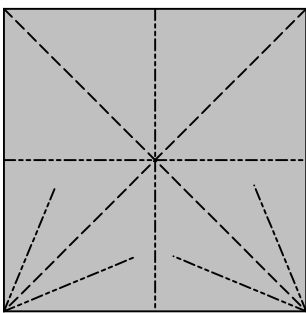
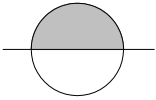

1. *Color for the feet up. Fold and unfold.*

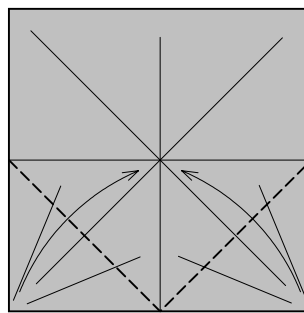

2.

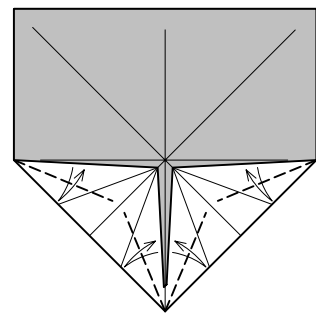

3. *Fold and unfold.*

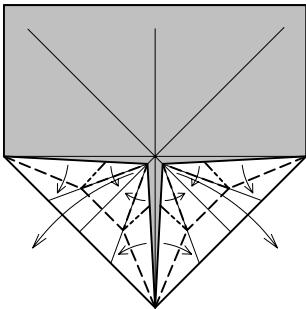

4.

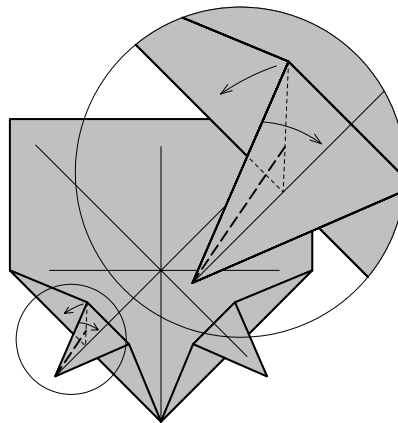

5. *Fold allowing paper to warp. The next two steps will flatten the model.*

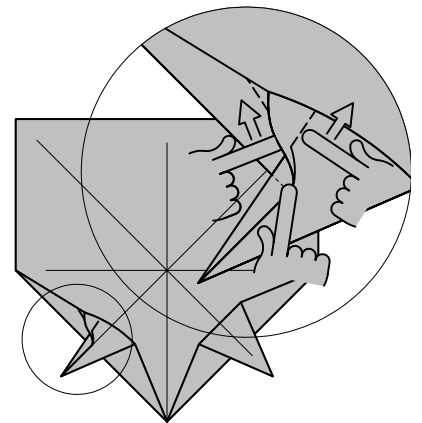

6. *Pressing the paper in the indicated point, slide fingers several times as shown and valley folds will appear at their correct locations.*

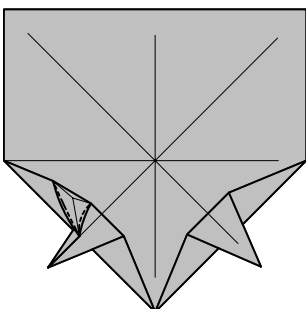

7. *Flatten the model*

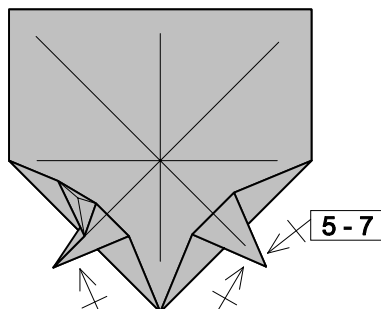

8.

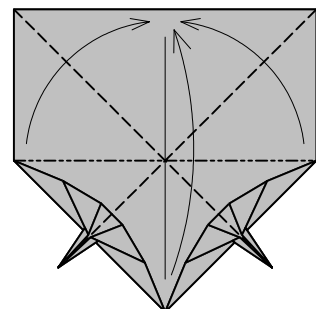

9.

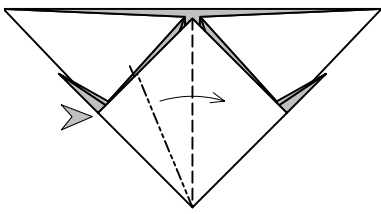

10.

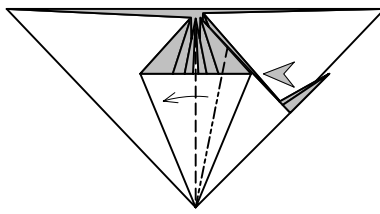

11.

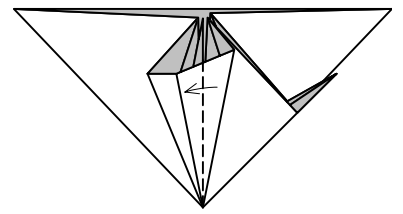

12.

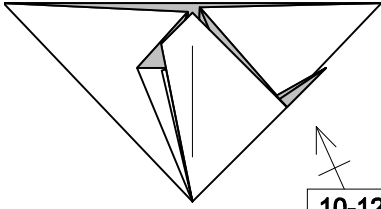

10-12

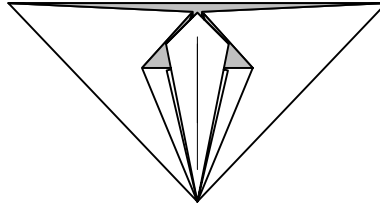

14.

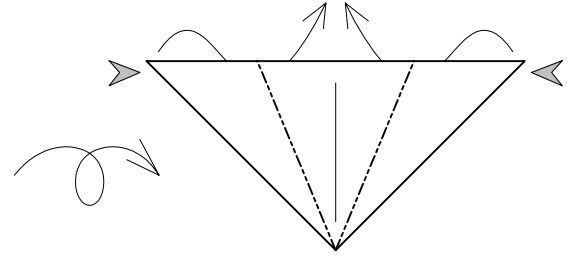

15.

13. Repeat on the other side.

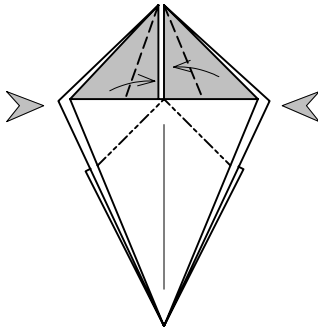

16.

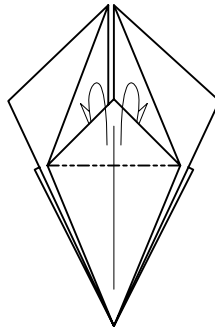

17.

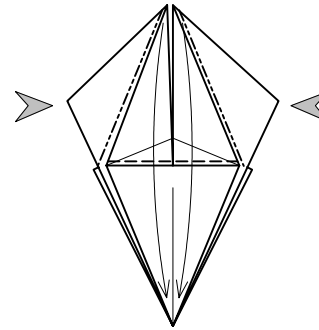

18.

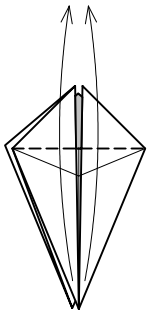

19.

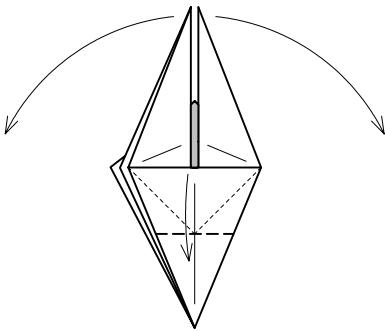

20.

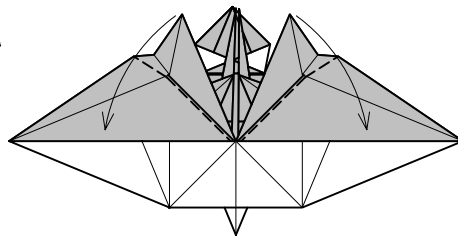

21.

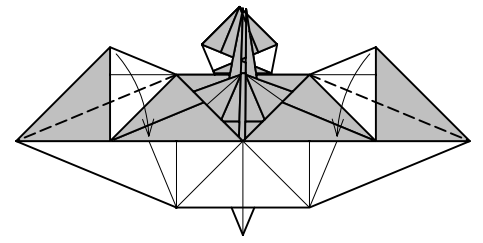

22.

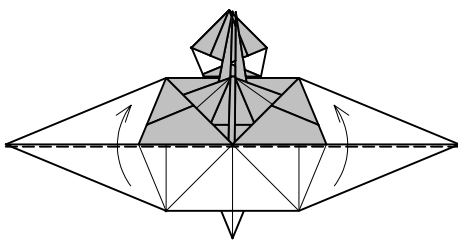

23.

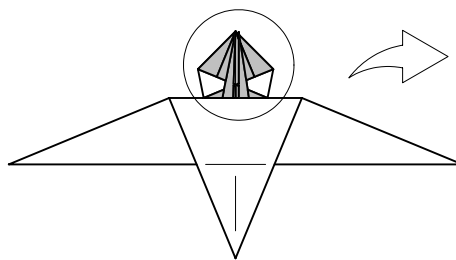

24

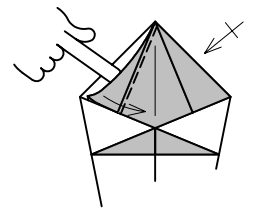

25.

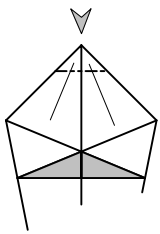

26.

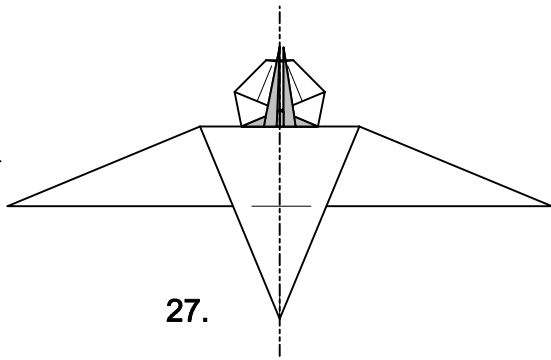
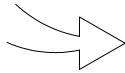

27.

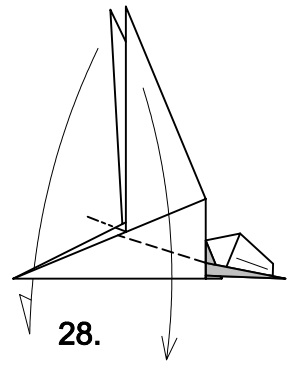

28.

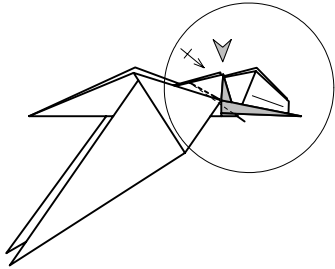

29.

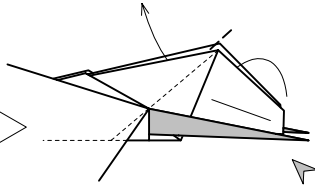
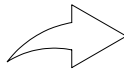

30.

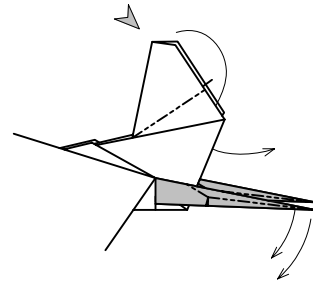

31.

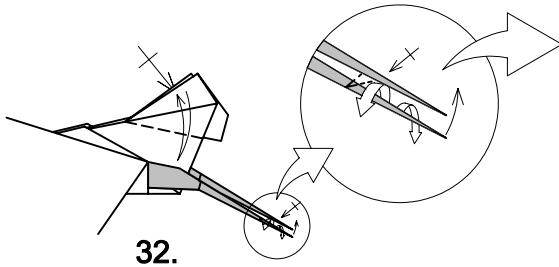

32.

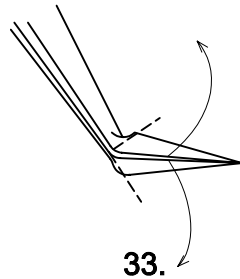

33.

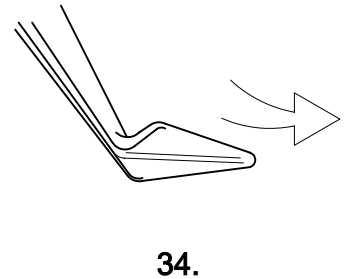

34.

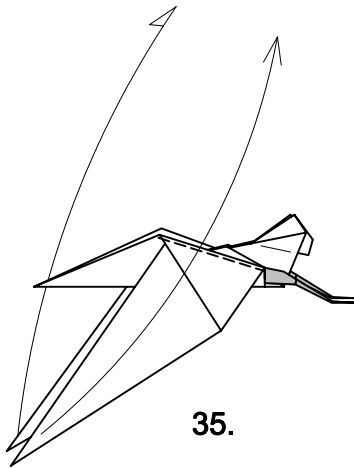

35.

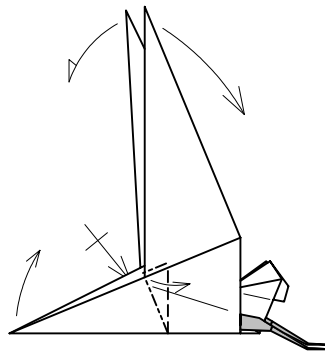

36. *Allow the wings to bend freely without any additional crease.*

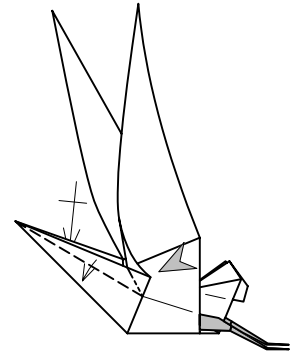

37.

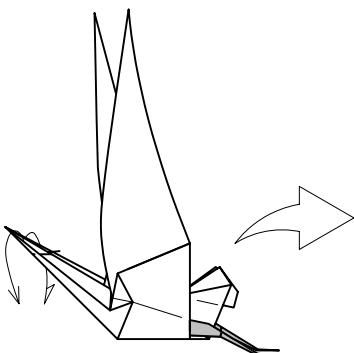

38. *Try to fold this step and the next one simultaneously, to avoid thickness troubles.*

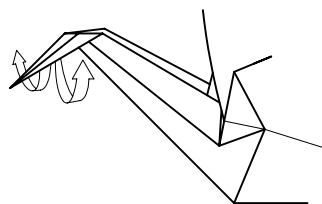

39.

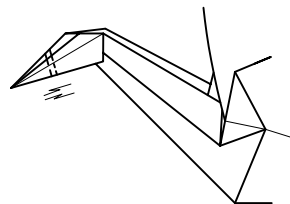

40.

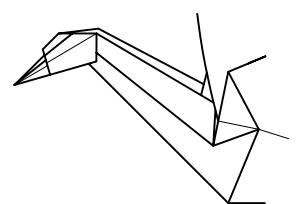

41.

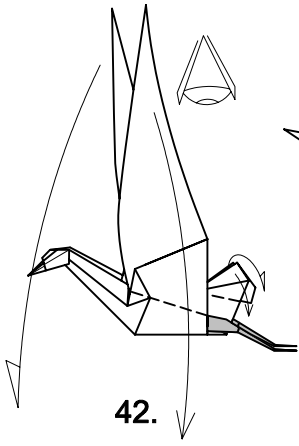

42.

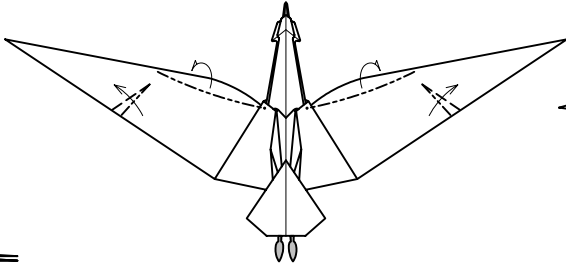

43.

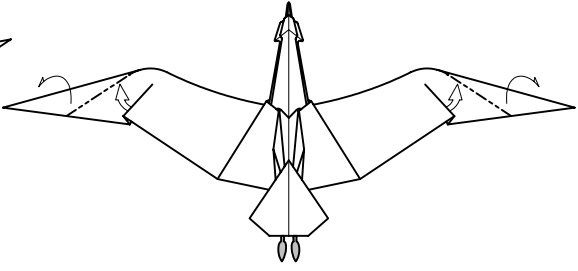

44.

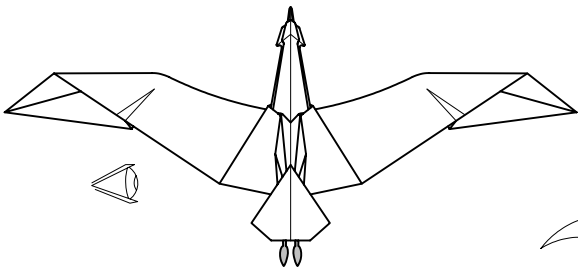

45.

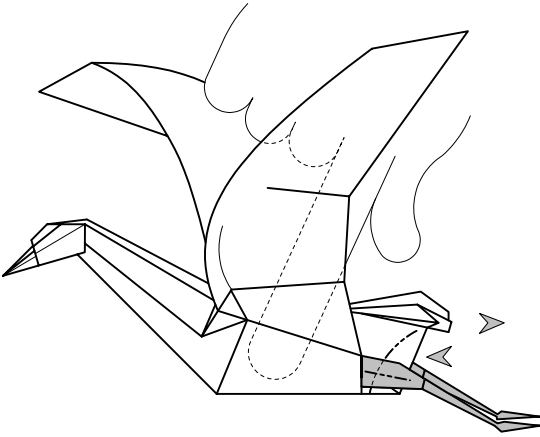

46.

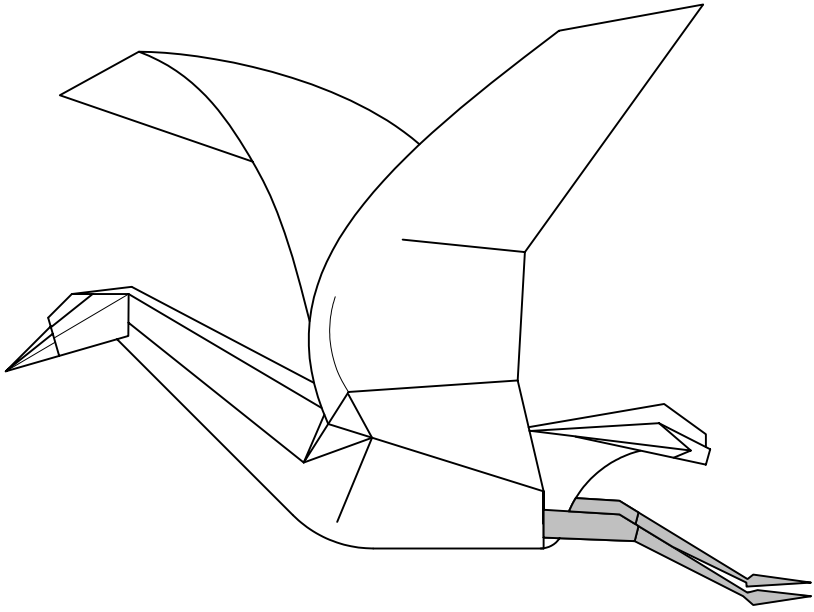

47.